

Double Regulating Balancing Valve - FODRV

LV 2489

Screwed BSPP, DZR Brass Body, Disc & Stem, Fixed Orifice, includes Test Points, Lock Feature



Pressure / Temperature Specifications	
Pressure	PN25
Temperature	-10°C to 120°C

Material List	
1. Body	CW602N DZR Brass CuZn36Pb2As
2. Disc	CW602N DZR Brass CuZn36Pb2As
3. Stem	CW602N DZR Brass CuZn36Pb2As
4. Handwheel	Polyamid
5. Test Points	CuZn36Pb2As + EPDM

Dimensions								
Size	L1	H	S	L2	L3	D1	D2	Kg
1/2"	77	95	27	13.5	15	1/2"	8.5	0.41
3/4"	82	105	33	14	14.5	3/4"	14.5	0.45
1"	97	113	41	15	17	1"	18.5	0.7
1 1/4"	115	123	49	19	19	1 1/4"	24.5	1.0
1 1/2"	129	133	56	19	19	1 1/2"	31	1.3
2"	152	141	68	23.5	23.5	2"	38	1.8

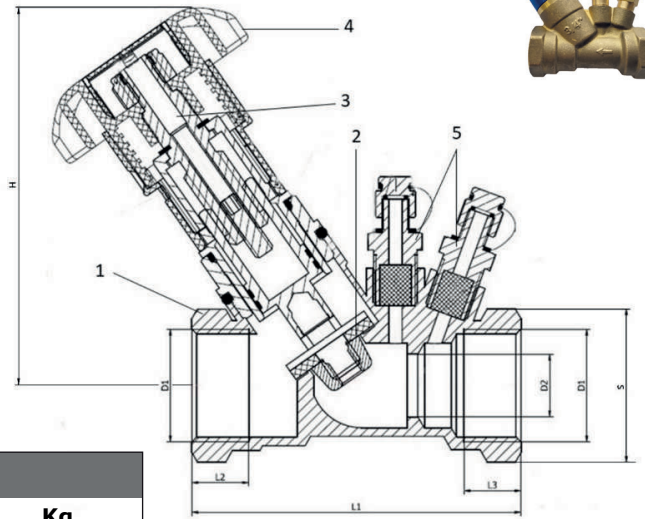

Flow rates & Charts on following pages

Double Regulating Balancing Valve - FODRV

LV 2489

Kv Values (m ³ /h)						
Size	1/2"	3/4"	1"	1 1/4"	1 1/2"	2"
0.5	1.00	2.71	2.48	4.52	5.13	7.07
0.6	1.05	2.88	2.65	4.92	5.66	7.59
0.7	1.11	3.05	2.83	5.31	6.18	8.11
0.8	1.16	3.21	3.00	5.71	6.71	8.63
0.9	1.22	3.38	3.18	6.10	7.23	9.15
1	1.27	3.55	3.35	6.50	7.76	9.67
1.1	1.30	3.62	4.46	6.74	8.07	10.01
1.2	1.33	3.68	3.57	6.99	8.38	10.35
1.3	1.37	3.75	3.69	7.23	8.70	10.69
1.4	1.40	3.81	3.80	7.48	9.01	11.03
1.5	1.43	3.88	3.91	7.72	9.32	11.37
1.6	1.46	3.93	4.00	7.89	9.58	11.69
1.7	1.50	3.98	4.09	8.06	9.84	12.01
1.8	1.53	4.02	4.17	8.24	10.10	12.34
1.9	1.57	4.07	4.26	8.41	10.36	12.66
2	1.60	4.12	4.35	8.52	10.62	12.98
2.1	1.63	4.16	4.44	8.75	10.90	13.30
2.2	1.66	4.20	4.53	8.92	11.18	13.62
2.3	1.70	4.25	4.62	9.10	11.45	13.93
2.4	1.73	4.29	4.71	9.27	11.73	14.25
2.5	1.76	4.33	4.80	9.44	12.01	14.57
2.6	1.81	4.37	4.92	9.61	12.36	14.91
2.7	1.86	4.41	5.04	9.79	12.70	15.26
2.8	1.90	4.45	5.16	9.96	13.05	15.60
2.9	1.95	4.49	5.28	10.14	13.39	15.95
3	2.00	4.53	5.40	10.31	13.74	16.29
3.1	2.04	4.57	5.55	10.47	14.03	16.68
3.2	2.09	4.62	5.71	10.62	14.32	17.08
3.3	2.13	4.66	5.86	10.78	14.60	17.47
3.4	2.18	4.71	6.02	10.93	14.89	17.87
3.5	2.22	4.75	6.17	11.09	15.18	18.26
3.6	2.24	4.79	6.30	11.34	15.45	18.68
3.7	2.27	4.83	6.42	11.58	15.72	19.09
3.8	2.29	4.86	6.55	11.83	15.99	19.51
3.9	2.32	4.90	6.67	12.07	16.26	19.92
4	2.34	4.94	6.80	13.32	16.53	20.34
KVsig	2.28	7.79	11.91	21.00	33.66	49.81

Last updated 10/08/2023

Double Regulating Balancing Valve - FODRV

LV 2489

Kvsig Chart

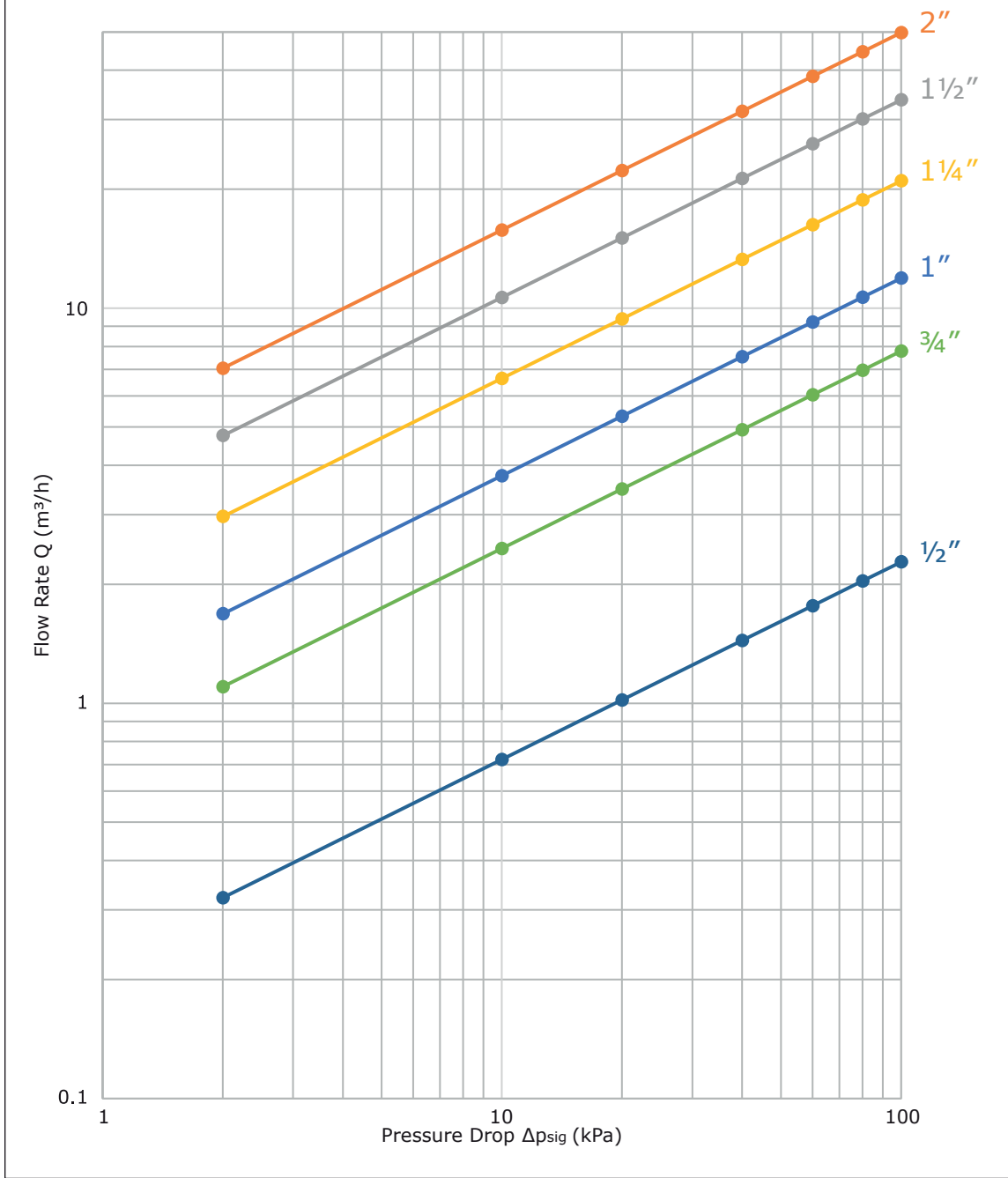

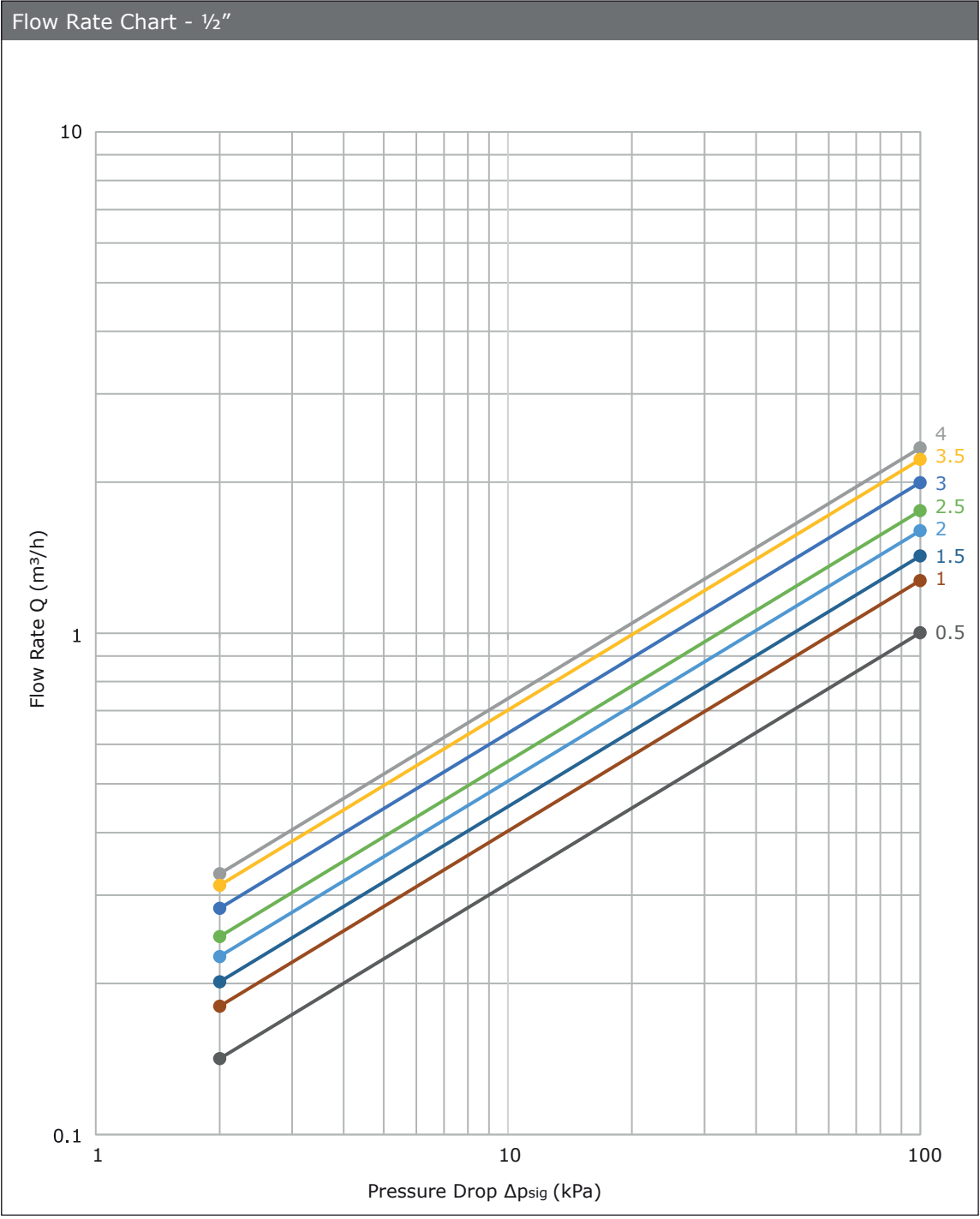

Double Regulating Balancing Valve - FODRV

LV 2489

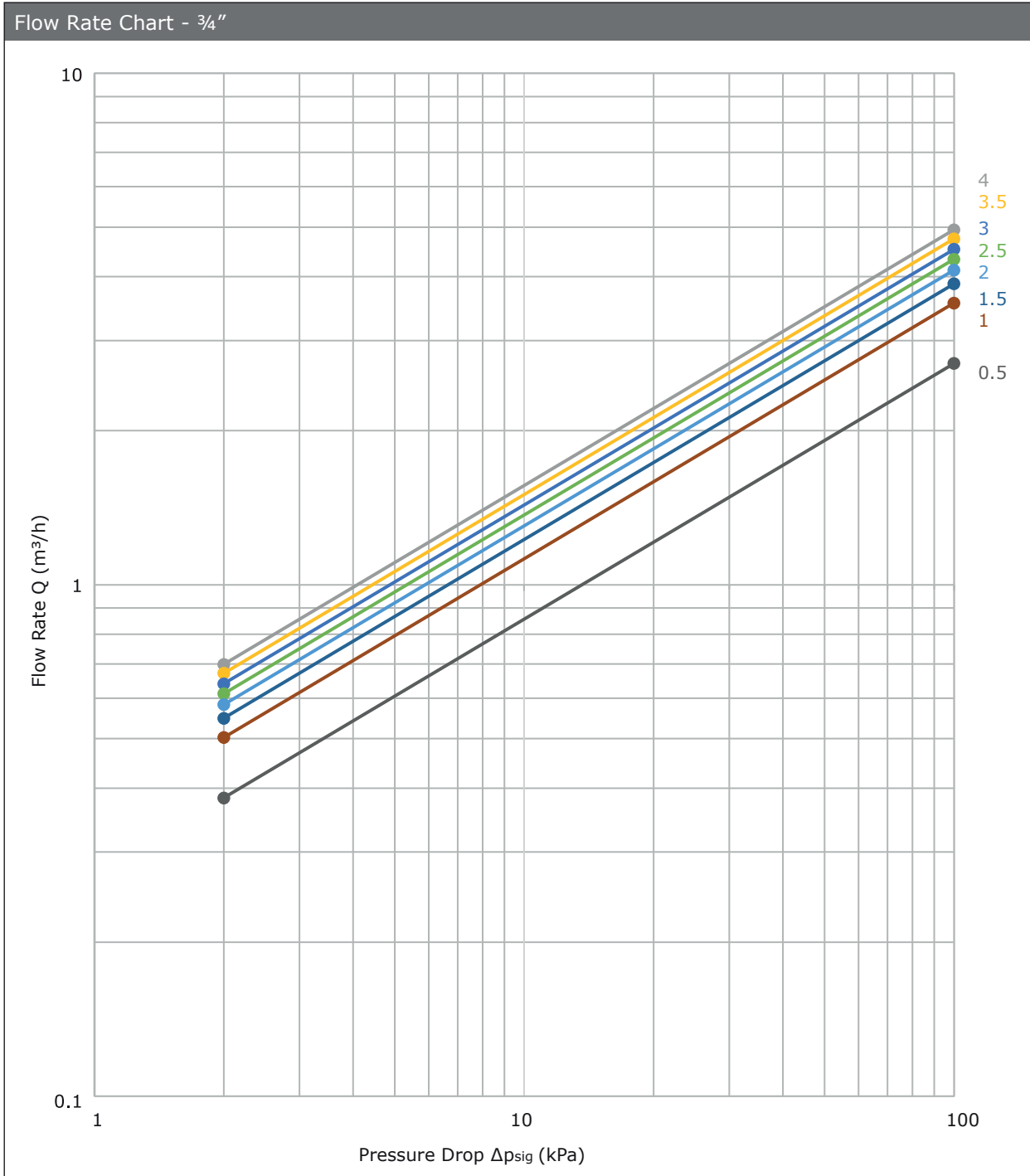

Double Regulating Balancing Valve - FODRV

LV 2489

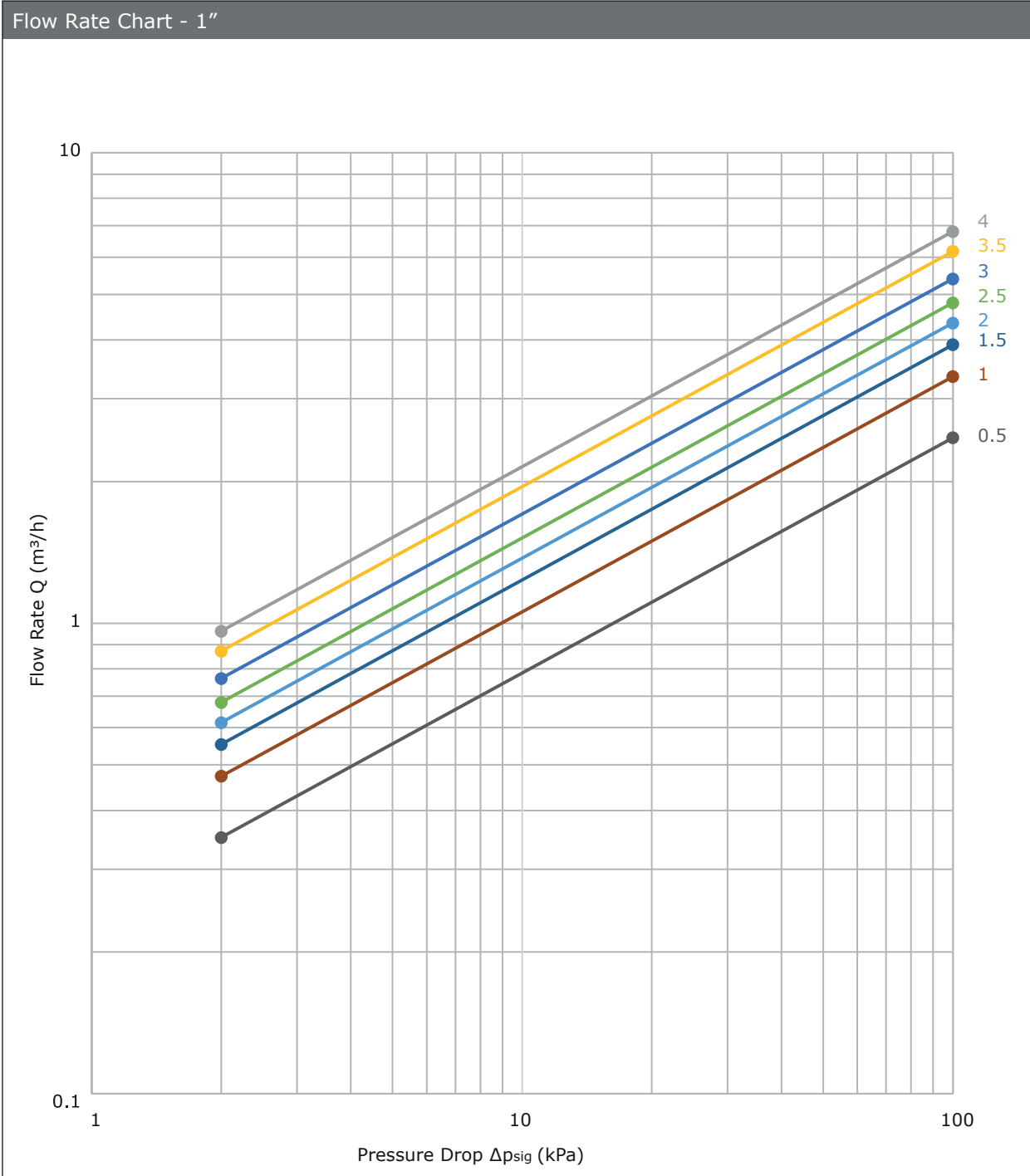

Double Regulating Balancing Valve - FODRV

LV 2489

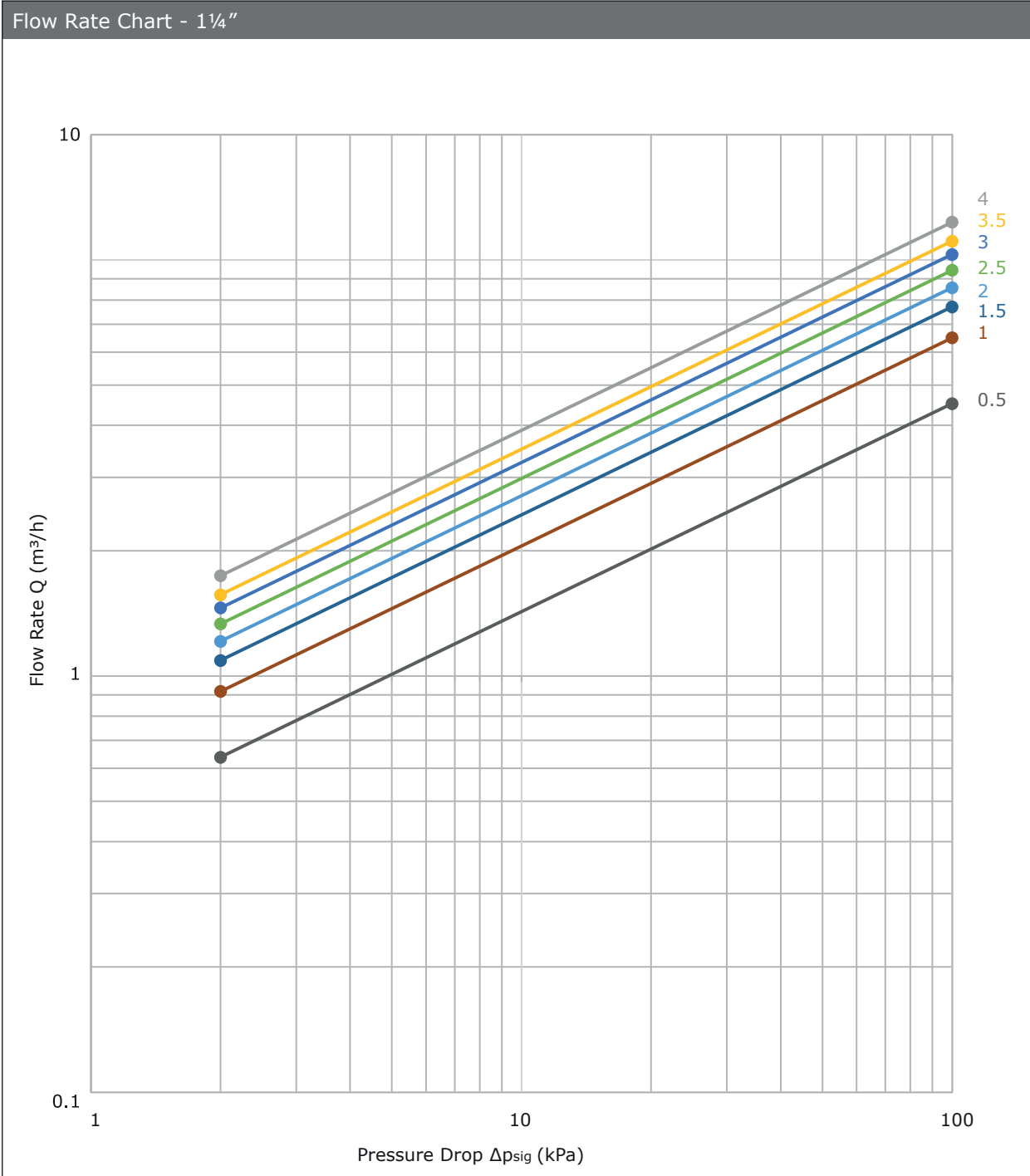

Double Regulating Balancing Valve - FODRV

LV 2489

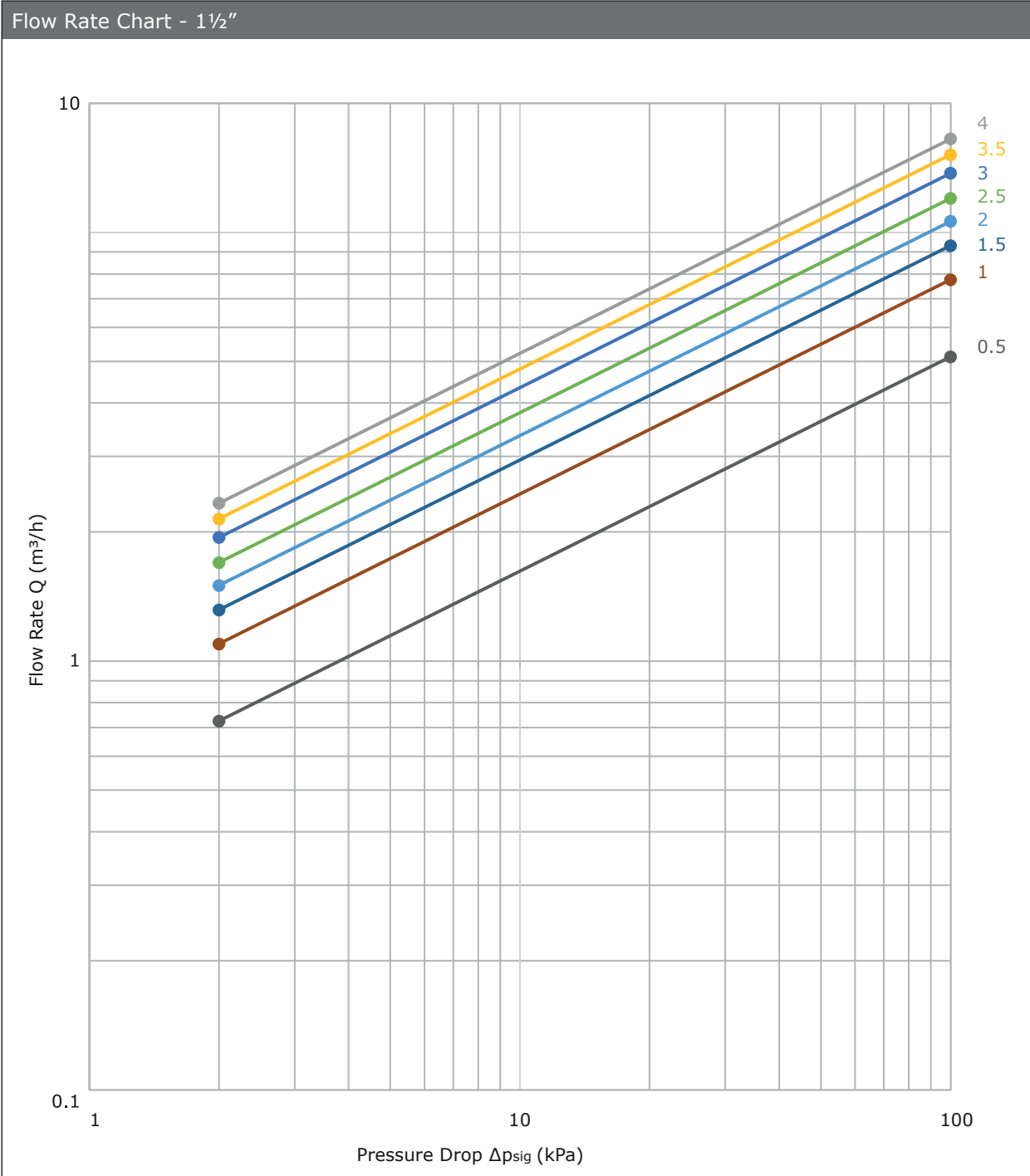

Double Regulating Balancing Valve - FODRV

LV 2489

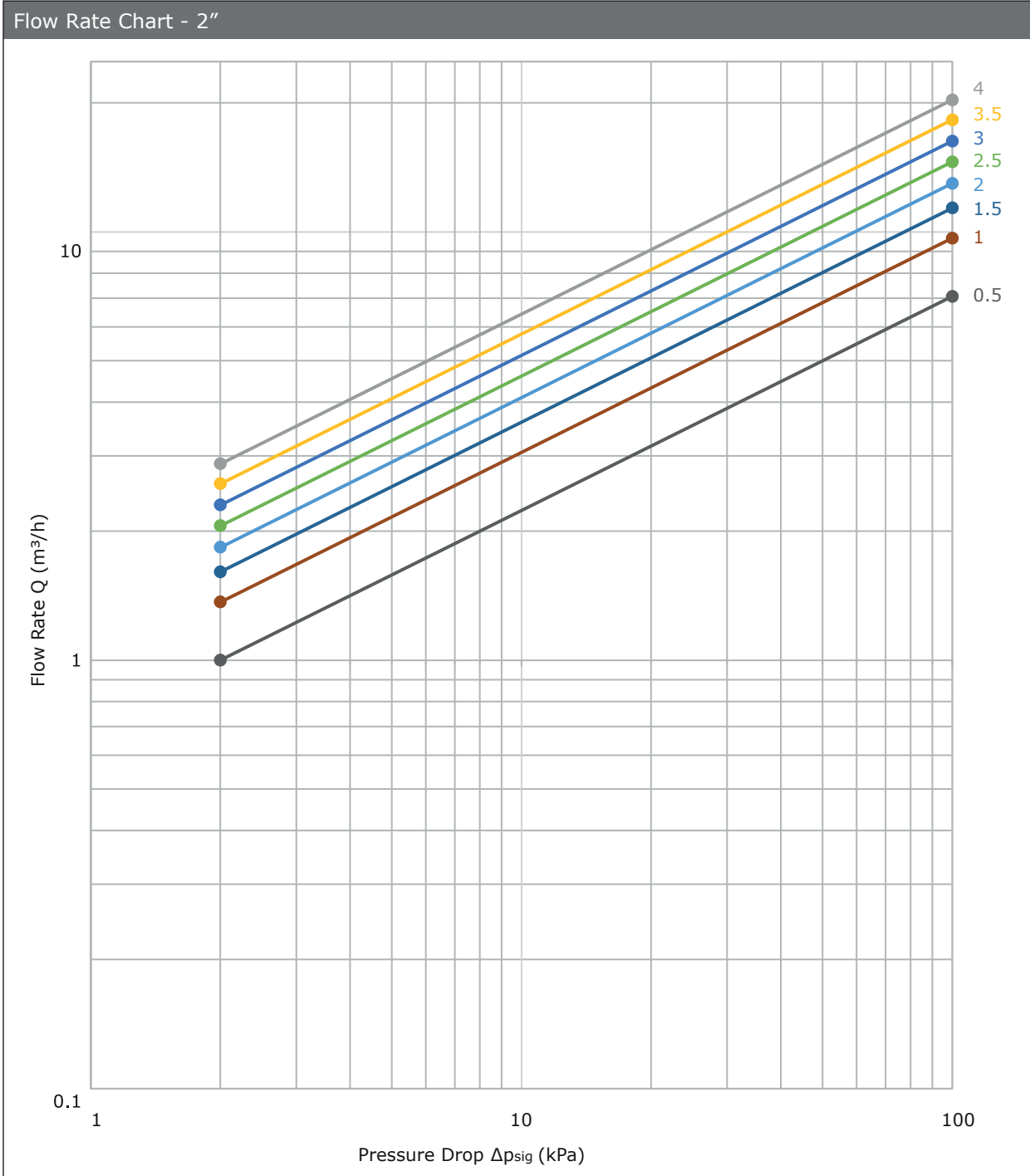

Double Regulating Balancing Valve - FODRV

LV 2489

Settings

